



CATÁLOGO
2024
ACESSÓRIOS
DE SOLDADURA

MAIS DE 70 ANOS DE EXPERIÊNCIA NO RAMO DA SOLDADURA

Quando João Rodrigues de Matos concebeu os primeiros equipamentos de soldadura em 1946, estava longe de imaginar a importância e a repercussão que a marca Electrex possui atualmente em todo o globo.

Mais de 70 anos percorridos, a Electrex mantém uma presença a nível mundial nos mais diversificados mercados com grande influência no mundo da soldadura. O rigor e a confiança que caracterizam as relações com os nossos clientes são a chave de sete décadas de sucesso.



WELDING SINCE
1946

Joseph P. ...

1917 - 2008

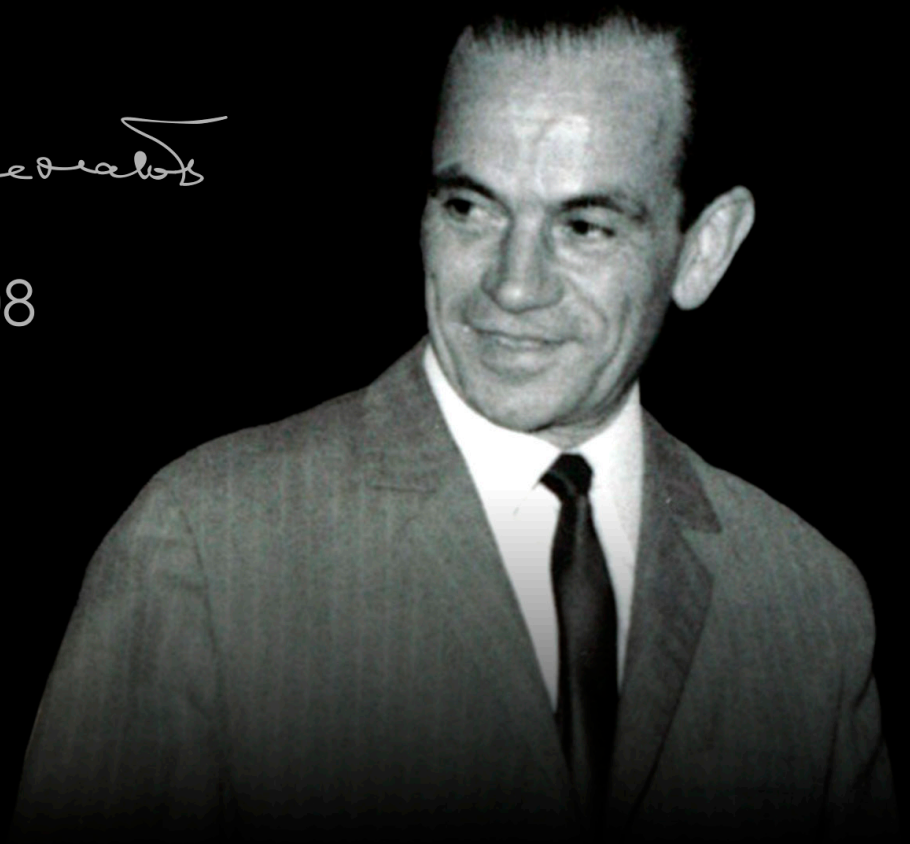

MAIS DE 70 ANOS DE EXPERIÊNCIA NO RAMO DA SOLDADURA

UMA MARCA PARA O CLIENTE



A Electrex coloca todo o seu empenho e esforço na satisfação das necessidades dos seus clientes, oferecendo soluções flexíveis e à medida de cada um. Cada pedido é executado com o máximo cuidado e rigor possível para satisfazer da melhor forma as necessidades dos nossos clientes.

RECURSOS HUMANOS



O recurso mais valioso de uma empresa está nas pessoas que todos os dias depositam o seu empenho na organização. A Electrex está consciente desse valor e por isso esforça-se por satisfazer as necessidades dos seus colaboradores proporcionando-lhes as melhores condições de trabalho possíveis, como forma de manter um ambiente de trabalho saudável e motivante.

FORNECEDORES



Os nossos fornecedores são peças fundamentais na grande engrenagem que é a Electrex e são selecionados cuidadosamente, desde o momento da encomenda das matérias primas até à chegada dos produtos às mãos dos nossos clientes. São os fornecedores que ajudam a organização a cumprir prazos e objetivos, para que os produtos sejam produzidos rapidamente e com qualidade, atendendo à demanda dos nossos clientes.

INOVAÇÃO



A Electrex procura todos os dias oferecer mais e melhor aos seus clientes, e por isso é exigida a procura constante por processos de produção mais inovadores de forma a desenvolver produtos de elevada exigência e qualidade que satisfaçam as necessidades dos nossos clientes.

SUSTENTABILIDADE



A Electrex está empenhada em manter o planeta livre de poluição para que as futuras gerações possam habitá-lo de igual forma. A Electrex cumpre todas as normas ambientais e de segurança impostas pelas respetivas entidades competentes, quer a nível europeu como global.

DESAFIOS FUTUROS



Um investimento na área da produção e a aposta nos mais recentes processos de produção, são alguns dos desafios a que se propõe a Electrex, para que possa oferecer aos seus clientes os melhores equipamentos de soldadura disponíveis no mercado. A Electrex leva muito a sério o seu trabalho como fabricante de equipamentos de soldadura e brevemente pretende diversificar os seus mercados de exportação e consolidar a sua presença nos já existentes.

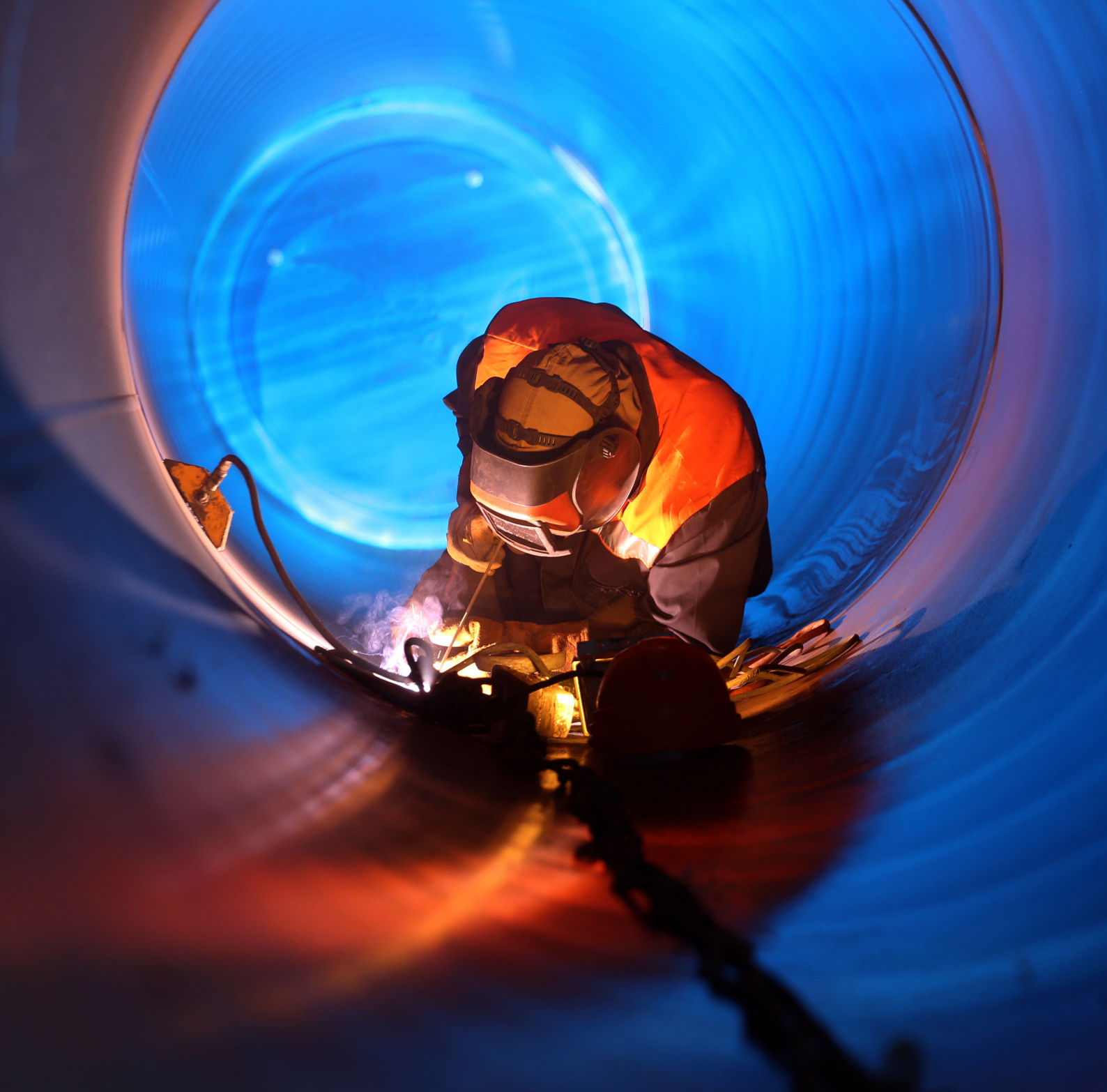

 **ELECTREX**[®]
welding since 1946

Reserva-se o direito de mudar as especificações técnicas sem aviso prévio, imagens não contratuais.



Management
System
ISO 9001:2015



www.tuv.com
ID 9108645664

ÍNDICE



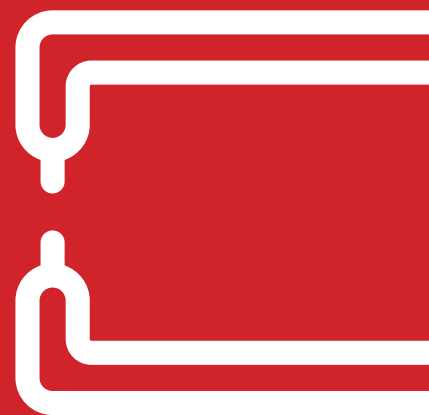
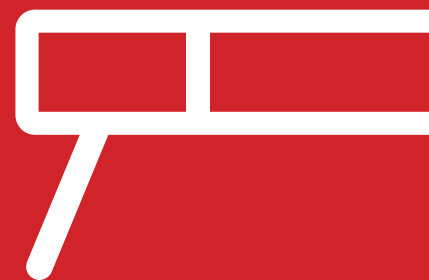

P. 7	Índice
P. 8	Acessórios e consumíveis
P. 11	Acessórios de proteção
P. 12	Acessórios MIG/MAG
P. 20	Acessórios TIG
P. 30	Acessórios SPOT
P. 32	Acessórios GÁS
P. 40	Acessórios PLASMA
P. 44	Serviços Electrex





ACESSÓRIOS SOLDADURA

Alicates soldadura	Ref.	
	Alicate soldadura Eco 160A	CO7ASL16008
	Alicate soldadura Eco 200A	CO7ASL20012
	Alicate soldadura Eco 300A	CO7ASL30005
	Alicate soldadura Eco 400A	CO7ASL40005
	Alicate soldadura Eco 600A	CO104538
	Alicate soldadura Optimal 300A	CO7ASL30002
	Alicate soldadura Optimal 400A	CO7ASL40002
	Alicate soldadura Optimal 500A	CO7ASL50002
	Alicate soldadura Optimal 600A	CO7ASL60002
	Alicate soldadura Samson 300A	CC103043
	Alicate soldadura Samson 400A	CC103044
	Alicate soldadura Samson 600A	CC114283
	Alicate soldadura Rotativo 300A	CC104539
	Alicate soldadura Rotativo 400A	CC103601
	Alicate soldadura Rotativo 600A	CC103602
	Alicate soldadura 90° Progress 600A	CC104536

Alicates massa/arc-air	Ref.	
	Alicate massa OX 200A	CO7AMS20011
	Alicate massa OX 250A	CO7AMS25006
	Alicate massa OX 400A	CO7AMS40007
	Alicate massa OX 500A	CO7AMS50009
	Alicate massa latão OX 200A	CC114280
	Alicate massa latão OX 400A	CC114281
	Alicate massa latão OX 600A	CC114282
	Grampo massa aço OX 600A	CO7AMS60010
	Grampo massa latão OX 700A	CO7AMS70010
	Massa magnética	CC114284
	Alicate arc-air ELECTREX 800A 2mt	CO7AA60017
	Alicate arc-air ELECTREX 800A 5mt	PA101876
	Alicate arc-air ELECTREX 1000A 2mt	CO7AA80017
	Alicate arc-air ELECTREX 1000A 5mt	PA101877



Escovas/picadeiras	Ref.	
	Escova/picadeira	CO7PM1265250
	Escova aço pequena (2 filas)	CO7PS1295252
	Escova aço grande (4 filas)	CO7PS1300254
	Escova inox grande	CO7PS2295254
	Picadeira média 225g	CO8PC225
	Picadeira média 525g	CO8PC525
	Picadeira metálica	CC114278
	Picadeira metálica com amortecedor	CC114279

Fichas rápidas/tomadas rápidas	Ref.	
	Ficha rápida macho 25mm ²	CO7USM02525
	Ficha rápida macho 50mm ²	CO7USM05050
	Ficha rápida macho 70mm ²	CO7USM07070
	Ficha rápida macho 95mm ²	CO7USM09595
	Ficha rápida macho 120mm ²	CO104910
	Ficha rápida fêmea 25mm ²	CO7USF02525
	Ficha rápida fêmea 50mm ²	CO7USF05050
	Ficha rápida fêmea 70mm ²	CO7USF07070
	Ficha rápida fêmea 95mm ²	CO7USF09595
	Ficha rápida redução m-f 25-50mm ²	CO7USMF2550
	Tomada rápida fêmea 25mm ²	CO9NSF02525
	Tomada rápida fêmea 50mm ²	CO9NSF05050
	Tomada rápida fêmea 70mm ²	CO9NSF07070
Tomada rápida macho 70mm ²	CO105762	

Cabo soldadura	Ref.	
	Cabo soldadura 10mm ²	MP09130100F00
	Cabo soldadura 16mm ²	MP09130160F00
	Cabo soldadura 25mm ²	MP09130250F00
	Cabo soldadura 35mm ²	MP09130350F00
	Cabo soldadura 50mm ²	MP09130500F00
	Cabo soldadura 70mm ²	MP09130700F00
	Cabo soldadura 95mm ²	MP09130950F00
	Cabo soldadura 120mm ²	MP09131200F00



ACESSÓRIOS SOLDADURA

Esquadros magnéticos

Ref.



Esquadro magnético 12kg

CC114285

Esquadro magnético 20kg

CC114286

Esquadro magnético 36kg

CC114287

Esquadro magnético 43kg

CC114288

Estufas elétrodos

Ref.



Estufa 5kg sem termostato

CC102467

Estufa 9kg com termostato

CC102468

Estufa 22kg com termostato e rodas

CC102469

Estufa 200kg com termostato

CC103612

Acessórios para tubos

Ref.



Grampo aberto tubos 1-12.5" (25-60mm)

CC114848

Grampo aberto tubos 2-6" (50-150mm)

CC114849

Grampo aberto tubos 5-14" (125-360mm)

CC114850

Suporte tubos HJ (28-49" / 735-1190mm)
1135 Kg

CC114851

Suporte tubos HJ (32-52" / 810-1320mm)
2500 Kg

CC114855

Roda aço suporte tubos HJ

CC114852

Roda borracha suporte tubos HJ

CC114853

Debitômetros

Ref.



Debitômetro ELECTREX Ar/CO2

CC104219

Debitômetro coluna ELECTREX Ar/CO2

CC104224

Debitômetro ELECTREX Ar/CO2 mini

CC109068

Economizador gás ELECTREX

CC108184

Tester gás

CC4000A131025

Anel vedação debitômetro

CC4000A102002

Outros acessórios MMA

Ref.





Suporte magnético alicate soldadura



CC109735



Maleta 42X34X25







CO6P246423425

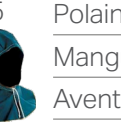
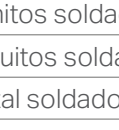

Máscaras de soldadura	Ref.	
	Máscara ELECTREX S 413	CC111221
	Máscara ELECTREX X 413	CC111222
	Filtro proteção interior S-413	CC111428
	Filtro proteção exterior S-413	CC111427
	Filtro proteção interior X-413	CC111433
	Filtro proteção exterior X-413	CC111432
	Suporte cabeça p/máscara X-413	CC111435
	Suporte cabeça p/máscara S-413	CC111430
	Banda anti-suor S-413	CC111431
	Banda anti-suor X-413	CC111436
	Máscara mão MM1010	PF109634
	Máscara cabeça MC1010	PF109633
	Máscara cabeça viseira móvel MC1010FU	PF108880
	Vidro inatinico DIN10 50X105mm	CO9GI1050105
	Vidro inatinico DIN11 50X105mm	CO9GI1150105
	Vidro inatinico DIN12 50X105mm	CO9GI1250105
	Vidro incolor 50X105mm	CO9GP0050105

Luvas	Ref.	
	Luva MIG ELECTREX (L) (1)	CC111491
	Luva MIG ELECTREX (M) (1)	CC111492
	Luva MIG alta temperatura ELECTREX (L) (2)	CC111495
	Luva TIG ELECTREX (L) (3)	CC111493
	Luva TIG ELECTREX (M) (3)	CC111494

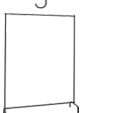
Vestuário	Ref.	
	Polainitos soldador (1)	CC4006A110001
	Manguitos soldador (2)	CC100275
	Avental soldador (3)	CC4006A150001
	Casaco soldador crute (4)	CC104262
	Capuz soldador algodão (5)	CC102881

Cortinas e acessórios	Ref.	
	Cortina laranja 1800X1300 (1)	CC4006P1418C1L
	Cortina verde 1800X1300 (2)	CC103897
	Cortina laranja 4 lâminas 1800X570mm (3)	CC4006P1418B2L
	Cortina laranja 5 lâminas 1800X465mm (4)	CC4006P1418A1L
	Estrutura suspensão cortina (5)	PA103349
	Anilha suspensão cortina (6)	CC4000P021040



CONSUMÍVEIS MIG/MAG

Tochas MIG ELECTREX

Tocha MIG 15



Diâmetro de fio:
Ø 0,6-1,0mm

CO2: 60% 180A
Mixed gas: 60% 150A

Tocha 3m	CC107207
Tocha 4m	CC107208

Tocha MIG 25



Diâmetro de fio:
Ø 0,8-1,2mm

CO2: 60% 230A
Mixed gas: 60% 200A

Tocha 3m	CC107209
Tocha 4m	CC107210

Tocha MIG 36



Diâmetro de fio:
Ø 0,8-1,2mm

CO2: 60% 320A
Mixed gas: 60% 290A

Tocha 3m	CC107211
Tocha 4m	CC107212
Tocha 5m	CC114572

Tocha DIGIMIG 36



Diâmetro de fio:
Ø 0,8-1,2mm

CO2: 60% 320A
Mixed gas: 60% 290A

Tocha 3m	CC108734
Tocha 4m	CC108735

Tocha MIG 40



Diâmetro de fio:
Ø 1,0-1,6mm

CO2: 60% 400A
Mixed gas: 60% 380A

Tocha 3m	CC113363
Tocha 4m	CC113364

Tocha MIG 240W



Diâmetro de fio:
Ø 0,8-1,2mm

CO2: 100% 300A
Mixed gas: 100% 270A

Tocha 3m	CC110950
Tocha 4m	CC110951

Tocha MIG 501W



Diâmetro de fio:
Ø 1,0-1,6mm

CO2: 60% 500A
Mixed gas: 60% 450A

Tocha 3m	CC107215
Tocha 4m	CC107216
Tocha 5m	CC114573

Tocha DIGIMIG 501W



Diâmetro de fio:
Ø 1,0-1,6mm

CO2: 60% 500A
Mixed gas: 60% 450A

Tocha 3m	CC108732
Tocha 4m	CC108733

Tocha MIG 605W



Diâmetro de fio:
Ø 1,0-1,6mm

CO2: 100% 600A
Mixed gas: 100% 550A
Pulse: 100% 450A

Tocha 4m	CC108101
----------	----------

Tocha MIG Push-Pull



Diâmetro de fio:
Ø 0,8-1,2mm
36 Spool
CO2: 60% 300A
Mixed gas: 60% 270A

Diâmetro de fio:
Ø 0,8-1,2mm
36 Push-Pull
CO2: 60% 300A
Mixed gas: 60% 270A

Diâmetro de fio:
Ø 1,0-1,6mm
401W Push-Pull
CO2: 60% 500A
Mixed gas: 60% 450A

Tocha 36 Spool 6m	CC113284
Tocha 36 Push-Pull 8m	CC109976
Tocha 401W Push-Pull 8m	CC108097

Tocha TBi MOG 70



Diâmetro de fio:
Ø 1,6-3,2mm

60% 430A

Tocha TBi MOG 70	PA112294
------------------	----------



Tochas OX MIG/MAG

Tocha MIG 15



3m	CC1015X181030
4m	CC1015X181040

Tocha MIG 24



3m	CC110205
4m	CC110206

Tocha MIG 25



3m	CC1025X181030
4m	CC1025X181040
5m	CC107174

Tocha MIG 36



3m	CC1036X181030
4m	CC1036X181040
5m	CC107175

Tocha MIG 501



3m	CC1501B181030
4m	CC1501B181040

Bicos contacto

Ref.



Bico contacto M6X6X0,6mm	CC1015A031061
Bico contacto M6X6X0,8mm	CC1015A031062
Bico contacto M6X6X1,0mm	CC1015A031063
Bico contacto M6X8X0,8mm	CC1000A031062
Bico contacto M6X8X1,0mm	CC1000A031063
Bico contacto M6X8X1,2mm	CC1000A031064
Bico contacto M6X8X1,6mm	CC1000A031065
Bico contacto M8X10X0,8mm	CC1000A031082
Bico contacto M8X10X1,0mm	CC1000A031083
Bico contacto M8X10X1,2mm	CC1000A031084
Bico contacto M8X10X1,6mm	CC1000A031085
Bico contacto M8X10X2,0mm	CC1000A031086
Bico contacto M8X10X2,4mm	CC1000A031087
Bico contacto M6X8X0,8mm CuCrZr	CC1000A032062
Bico contacto M6X8X1,0mm CuCrZr	CC1000A032063
Bico contacto M6X8X1,2mm CuCrZr	CC1000A032064
Bico contacto M8X10X0,8mm CuCrZr	CC1000A032082
Bico contacto M8X10X1,0mm CuCrZr	CC1000A032083



CONSUMÍVEIS MIG/MAG

Bico contacto M8X10X1,2mm CuCrZr	CC1000A032084
Bico contacto M8X10X1,6mm CuCrZr	CC1000A032085
Bico contacto M8X10X2,4mm CuCrZr	CC1000A032087
Bico contacto M10X12X1,2mm CuCrZr	CC108106
Bico contacto M10X12X1,6mm CuCrZr	CC1000A032105
Bico contacto M10X12X2,4mm CuCrZr	CC1000A032107
Bico contacto M10X12X3,2mm CuCrZr	CC1000A032108

Bocais	Ref.	
	Bocal cónico 15	CC1015A040001
	Bocal cilíndrico 15	CC1015A040002
	Bocal estreito 15	CC1015A040003
	Bocal pontos 15	CC1015A040004
	Mola bocal 15	CC1015A150000
	Bocal cónico 24	CC1024A040001
	Bocal estreito 24	CC1024A0003
	Bocal cónico 25	CC1025A040001
	Bocal cilíndrico 25	CC1025A040002
	Bocal estreito 25	CC1025A040003
	Bocal pontos 25	CC1025A040004
	Mola bocal 25	CC1025A150000
	Bocal cónico 36	CC1036A040001
	Bocal cilíndrico 36	CC1036A040002
	Bocal cónico 40	CC1040A040001
	Bocal cónico 40 ELECTREX	CC113367
	Bocal cilíndrico 40 ELECTREX	CC113366
	Bocal cónico 501	CC1501A040001
	Bocal estreito 501	CC113093
	Bocal cilíndrico 501	CC113094
Bocal cónico 605	CC108105	
Adaptador bocal 605	CC108102	
Bocal cerâmico MOG70 53N61S 12,7mm #8	CC112382	



Difusores/Suportes bico	Ref.
Difusor 15 rosca direita	CC1015A07200D
Difusor 15 rosca esquerda	CC1015A07200E
Difusor cerâmico 24	CC1024A07400A
Suporte bico 24 M6	CC1024A250M06
Difusor 25 M6	CC1025A07100D
Difusor 25 M8	CC100285
Difusor 36	CC1036A07300A
Difusor cerâmico 36	CC1036A07400A
Suporte bico 36 M6	CC1036A250M06
Suporte bico 36 M8	CC1036A250M08
Difusor 40	CC1040A07300A
Difusor cerâmico 40	CC1040A07400A
Suporte bico 40 M8	CC1040A250M08
Difusor 501	CC1501A07300A
Difusor cerâmico 501	CC1501A07400A
Suporte bico 501 M6	CC1501A250M06
Suporte bico 501 M8	CC1501A250M08
Isolador lança 501	CC1401A130001
Difusor HP 605	CC108104
Suporte bico 605	CC108103
Suporte bico M10 MOG 70	CC105351





CONSUMÍVEIS MIG/MAG

Lanças		Ref.
	Lança 15	CC1015A1401D0
	Lança 24	CC1024A1401D0
	Lança 25	CC1025A1401D0
	Lança 36	CC1036A1401D0
	Lança 36 automática 45°	CC100587
	Lança 36 automática reta	CC1036A1402D0
	Lança 40	CC1040A1401D0
	Lança 40 ELECTREX	CC113365
	Lança 240W ELECTREX	CC108757
	Lança 501 ELECTREX	CC108153
	Lança 501 automática curva	CC101020
	Lança 501 automática reta	CC105444
	Lança 605 ELECTREX	CC108757
	Lança push-pull 36 curva 45°	CC109984
	Lança push-pull 36 reta	CC109985
	Lança push-pull 401 curva 45°	CC109986
	Lança push-pull 401 reta	CC108098
	Lança MOG 70	CC105350
	Punho automático reto	CC1000A200003



Bichas

Ref.

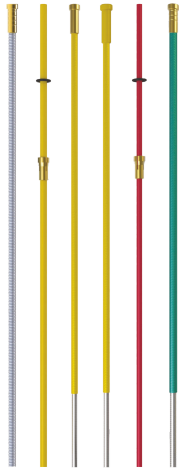

Bicha aço 0,6-0,8mm 3m	CC1000A021083
Bicha aço 0,6-0,8mm 4m	CC1000A021084
Bicha aço 0,6-0,8mm 5m	CC1000A021085
Bicha aço 1,0-1,2mm 3m	CC1000A021123
Bicha aço 1,0-1,2mm 4m	CC1000A021124
Bicha aço 1,0-1,2mm 5m	CC1000A021125
Bicha aço 1,2-1,6mm 3m	CC1000A021163
Bicha aço 1,2-1,6mm 4m	CC1000A021164
Bicha aço 1,2-1,6mm 5m	CC1000A021165
Bicha aço 2,0-2,4mm 3m	CC1000A021243
Bicha aço 2,0-2,4mm 4m	CC1000A021244
Bicha aço 2,8-3,2mm 3m	CC1000A021323
Bicha aço 2,0-2,4mm 3m MOG 70	CC105352
Bicha aço 2,8-3,2mm 3m MOG 70	CC106511
Bicha teflon 0,8-1,0mm 3m	CC102379
Bicha teflon 0,8-1,0mm 4m	CC102380
Bicha teflon 0,8-1,0mm 5m	CC102381
Bicha teflon 1,0-1,2mm 3m	CC1000A022123
Bicha teflon 1,0-1,2mm 4m	CC1000A022124
Bicha teflon 1,0-1,2mm 5m	CC1000A022125
Bicha teflon 1,2-1,6mm 3m	CC1000A022163
Bicha teflon 1,2-1,6mm 4m	CC1000A022164
Bicha teflon 1,2-1,6mm 5m	CC1000A022165
Mola p/ extremidade bicha teflon 1,2mm	CC103870
Mola p/ extremidade bicha teflon 1,6mm	CC108439



CONSUMÍVEIS MIG/MAG

Sprays	Ref.	
	Liquido refrigeração p/ equipam. soldadura 5l	PA113250
	Desmoldante pasta 250ml	CO7MELP0180
	Desmoldante spray 400ml	CO7MELS0400
	Spray cerâmico soldadura 400ml	CC109241
	Spray detetor fugas ECO83	CC108087
	Liquido anti-projeções G309 5 litros	CC108088
	Spray penetrante 12/34 400ml	CC102021
	Spray zinco 400ml	CC105487
	Spray revelador G164	CC100918
	Spray penetrante G151	CC100919
	Spray solvente G153	CC103174
	Spray inox 400ml	CC10.00036
	Gel limpeza inox 2Kg	CC100652
	Gel limpeza inox suave 2Kg	CC109173
	Pincel gel limpeza inox	CC10.10122



Outros consumíveis MIG	Ref.	
	Adaptador bobina fio pequeno	CC4000A160001
	Adaptador bobina fio grande (300mm)	CC4000A160002
	Adaptador bobina fio 25Kg	CO105585
	Desenrolador bobina completo	CO104292
	Desenrolador bobina 25kg completo	CO105270
	Proteção bobina fio alimentador	CO108651
	Campânula tambor SG2/SG3	CC114496
	Alinhador 5 rodas campânula tambor SG2/SG3	CC114497
	Guia fio p/ campânula tambor SG2/SG3	CC114498
	Alicate multi-uso MIG 12-15	CC100276
	Suporte magnético tocha MIG	CC102969
	Cerâmica circular 12mm	CC114427
	Cerâmica redonda 6mm	CC114428
	Cerâmica redonda 9mm	CC114429
	Cerâmica redonda 12mm	CC114430
	Cerâmica meia cana 6mm	CC114431
	Cerâmica meia cana 9mm	CC114432



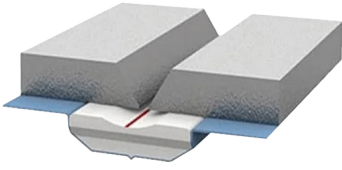

Cerâmica meia cana 13mm	CC114433
Cerâmica canal direito 6mm	CC114434
Cerâmica canal direito 9mm	CC114435
Cerâmica canal direito 13mm	CC114436

Tochas TIG ELECTREX

Tocha TIG 9



DC: 35% 125A
AC: 35% 90A

Tocha 4m	CC107200
Tocha 4m Flex	PA113372
Tocha 8m	CC108121
Tocha 8m Flex	PA113373

Tocha TIG 17



DC: 35% 150A
AC: 35% 105A

Tocha 4m	CC107201
Tocha 4m Flex	PA113374
Tocha 8m	CC107202
Tocha 8m Flex	PA113375

Tocha TIG 26



DC: 35% 180A
AC: 35% 125A

Tocha 4m	CC107203
Tocha 4m Flex	PA112948
Tocha 8m	CC107204
Tocha 8m Flex	PA113376

Tocha TIG 28



DC: 35% 300A
AC: 35% 250A

Tocha 4m	CC113385
Tocha 8m	CC113386

Tocha TIG 20W



DC: 100% 225A
AC: 100% 160A

Tocha 4m	CC108754
Tocha 8m	CC108119

Tocha TIG 18W



DC: 100% 380A
AC: 100% 275A

Tocha 4m	CC107205
Tocha 4m Flex	PA112948
Tocha 8m	CC107206
Tocha 8m Flex	PA113377

Tocha TIG 45W



DC: 100% 450A
AC: 100% 360A

Tocha 4m	CC113361
Tocha 8m	CC113362

Tocha TIG 24W



DC: 100% 180A
AC: 100% 125A

Tocha 4m	CC108755
----------	----------

Tochas TIG V ELECTREX

Tocha TIG 17V



DC: 35% 150A
AC: 35% 105A

Tocha 4m	CC108751
Tocha 8m	CC108752

Tocha TIG 26V



DC: 35% 180A
AC: 35% 125A

Tocha 4m	CC108120
Tocha 8m	CC108753

Outros

Ficha macho tocha TIG



CO107893

Tochas TIG Coldwire ELECTREX

Tocha TIG Coldwire



26 Coldwire
DC: 35% 180A
AC: 35% 125A
18W Coldwire
DC: 100% 380A
AC: 100% 275A

Tocha 26 Coldwire 4m	PA107921
Tocha 18W Coldwire 4m	PA107922

	Ref.
Punho alimentação mecanizado	PF108739
Punho alimentação manual	PF101366
Bico tocha coldwire 0,8-1,0mm	CC107064
Bico tocha coldwire 1,2-1,6mm	CC107065
Conjunto guia-fio coldwire tochas 17/26/18	CC2G05A19CW00

Tochas TIG Auto ELECTREX

Tochas OX TIG

Tocha Auto TIG WP 27A

Tocha Auto TIG WP 27B

Tocha TIG 9

Tocha TIG 17



DC: 60% 500A
AC: 60% 300A

DC: 60% 500A
AC: 60% 300A

Tocha 8m	CC104257
Tocha 12m	CC111664

Tocha 8m	CC104259
Tocha 12m	CC111665

4m	CC2009A130S04
8m	CC2009A130S08

4m	CC2017H130S04
8m	CC100442

Tocha TIG 18

Tocha TIG 20

Tocha TIG 26

























4m	CC2018A130S04
8m	CC2018A130S08

4m	CC2020H130S04
8m	CC2020H130S08

4m	CC2026H130S04
8m	CC2026H130S08



Cabeça tocha TIG	Ref.	
	Cabeça 9	CC103668
	Cabeça 9F	CC111343
	Cabeça 17	CC2017A020S00
	Cabeça 17V	CC2017A020V00
	Cabeça 17F	CC100650
	Cabeça 18	CC2018A020S00
	Cabeça 18F	CC108261
	Cabeça 18P	CC112626
	Cabeça 45W	CC113346
	Cabeça 20	CC2020A020S00
	Cabeça 20P	CC101295
	Cabeça 26	CC2026A020S00
	Cabeça 26F	CC100810
	Cabeça 26V	CC2026A020V00
	Cabeça 26VF	CC108312
	Cabeça auto 27A	CC111064

Interruptor tocha TIG	Ref.	
	Interruptor ELECTREX simples	CC108093
	Interruptor ELECTREX com alavanca	CC109995
	Interruptor ELECTREX com potenciômetro	CC108096
	Interruptor ELECTREX com 2 botões	CC110926
	Interruptor ELECTREX com 3 botões	CC108094
	Interruptor ELECTREX com 4 botões	CC108095

Tampão tocha TIG	Ref.
Tampão longo 57Y02	CC2G05A140L00
Tampão longo 41V24	CC2G07A140L00
Tampão longo 41V24L	CC112260
Tampão longo 45W	CC113354
Tampão médio 41V35	CC2G07A140M00
Tampão médio 300M	CC107863
Tampão curto 41V33	CC2G07A140C00
Tampão curto 57Y04	CC2G05A140C00
Tampão curto 45W	CC113355
Isolador TIG Pyrex 17/18/26 Jumbo	CC108986
Isolador TIG Pyrex 9/20 Jumbo	CC108991
Isolador 18CG	CC2G05A060000
Isolador prolongador gás 54N01	CC101398
Isolador 54N63 Jumbo	CC2G05A060001
Isolador 54N63-20 Jumbo	CC112612
Isolador 18-7	CC102950
Isolador 17GLG20 Stubby	CC108358
Isolador 18CG20 Stubby	CC108357
Isolador 598892 9/20	CC106432
Isolador tocha auto TIG 57N56	CC111066





ACESSÓRIOS TIG

Prolongadores de gás

Ref.



Prolongador gás 1,0mm 45V24	CC2G05A101000
Prolongador gás 1,0mm 45V42	CC2G07A101000
Prolongador gás 1,6mm 45V25	CC2G05A101600
Prolongador gás 1,6mm 45V43	CC2G07A101600
Prolongador gás 1,6mm 45V43L Stubby	CC108352
Prolongador gás Stubby 45V116S 1.6 mm	CC113096
Prolongador gás 2,4mm 45V26	CC2G05A102400
Prolongador gás 2,4mm 45V44	CC2G07A102400
Prolongador gás 2,4mm 45V44L Stubby	CC108353
Prolongador gás 2,4mm 45V64 Jumbo	CC2G05A102401
Prolongador gás 2,4mm 45V64S Jumbo	CC112548
Prolongador gás 2,4mm 49V24	CC111070
Prolongador gás 3,2mm 45V27	CC2G05A103200
Prolongador gás 3,2mm 45V45	CC2G07A103200
Prolongador gás 3,2mm 49V25	CC111069
Prolongador gás 3,2mm 995795 Jumbo	CC107994
Prolongador gás 3,2mm 995795S Jumbo	CC112613
Prolongador gás 4,0mm 45V28	CC2G05A104000
Prolongador gás 4,0mm 49V26	CC113095
Prolongador gás 45W	CC113356

Pinças TIG

Ref.





Pinça 1,0mm 17/18/26 10N22	CC2G05A071000
Pinça 1,0mm 9/20/25 13N21	CC2G04A071000
Pinça 1,0mm 24/24W 53N16	CC2G03A071000
Pinça 1,6mm 17/18/26 10N23	CC2G05A071600
Pinça 1,6mm 9/20/25 13N22	CC2G04A071600
Pinça 1,6mm 9/20 13N22L Jumbo	CC113396
Pinça 1,6mm 24/24W 53N14	CC2G03A071600
Pinça 1,6mm 17/18/26 10N23S Stubby	CC108354
Pinça 1,6mm 17/18/26 13N22 Stubby	CC108955
Pinça 2,0mm 17/18/26 10N26	CC2G05A072000
Pinça 2,0mm 70066 13N22M 9/20	CC2G01A072000



Pinça 2,4mm 17/18/26 10N24	CC2G05A072400
Pinça 2,4mm 17/18/26 Pyrex	CC113320
Pinça 2,4mm 9/20/25 13N23	CC2G04A072400
Pinça 2,4mm 9/20/25 13N23L Jumbo	CC112549
Pinça 2,4mm 9/20 Pyrex	CC113318
Pinça 2,4mm 24/24W 24C332	CC2G03A072400
Pinça 2,4mm 17/18/26 10N24S Stubby	CC108355
Pinça 2,4mm 17/18/26 13N23 Stubby	CC108956
Pinça 2,4mm 57N47	CC111072
Pinça 2,4mm 45W	CC113350
Pinça 3,2mm 17/18/26 10N25	CC2G05A073200
Pinça 3,2mm 17/18/26 Pyrex	CC113321
Pinça 3,2mm 9/20/25 13N24	CC2G04A073200
Pinça 3,2mm 9/20/25 13N24L Jumbo	CC112614
Pinça 3,2mm 9/20 Pyrex	CC113319
Pinça 3,2mm 57N48	CC111071
Pinça 3.2 mm 45W	CC113351
Pinça 4,0mm 17/18/26 54N20	CC2G05A074000
Pinça 4,0mm 57N49	CC112625
Pinça 4,0mm 45W	CC113352



ACESSÓRIOS TIG

Porta pinças	Ref.	
	Porta pinças 1,0mm 17/18/26 10N30	CC2G05A091000
	Porta pinças 1,0mm 9/20/25 13N26	CC2G04A091000
	Porta pinças 1,0mm 24/24W 53N18	CC2G03A091000
	Porta pinças 1,6mm 17/18/26 10N31	CC2G05A091600
	Porta pinças 1,6mm 9/20/25 13N27	CC2G04A091600
	Porta pinças 1,6mm 24/24W 53N19	CC2G03A091600
	Porta pinças 2,0mm 17/18/26 10N31M (13N27M)	CC2G05A092000
	Porta pinças 2,0mm 9/20 70067	CC2G01A092000
	Porta pinças 2,4mm 17/18/26 10N32	CC2G05A092400
	Porta pinças 2,4mm 9/20/25 13N28	CC2G04A092400
	Porta pinças 2,4mm 24/24W 24CB332	CC2G03A092400
	Porta pinças 3,2mm 17/18/26 10N28	CC2G05A093200
	Porta pinças 3,2mm 9/20/25 13N29	CC2G04A093200
	Porta pinças 3,5mm 17CB20 Stubby	CC108356
	Porta pinças 4,0mm 17/18/26 406488	CC2G05A094000
	Porta pinças Pyrex 17/18/26 Jumbo	CC108984
	Porta pinças Pyrex 9/20 Jumbo	CC108989
	Porta pinças 45W	CC113353



Elérodos tungsténio

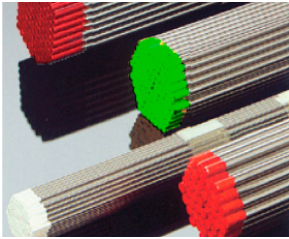

	Ref.
Elétrodo W 2% Tório 0,8mm 150mm (vermelho)	CC2000A042081
Elétrodo W 2% Tório 1,0mm 150mm (vermelho)	CC2000A042101
Elétrodo W 2% Tório 1,2mm 150mm (vermelho)	CC2000A042121
Elétrodo W 2% Tório 1,6mm 150mm (vermelho)	CC2000A042161
Elétrodo W 2% Tório 2,0mm 150mm (vermelho)	CC2000A042201
Elétrodo W 2% Tório 2,4mm 150mm (vermelho)	CC2000A042241
Elétrodo W 2% Tório 3,2mm 150mm (vermelho)	CC2000A042321
Elétrodo W 2% Tório 4,0mm 150mm (vermelho)	CC2000A042401
Elétrodo W 2% Cério 1,6mm 150mm (cinza)	CC101012
Elétrodo W 2% Cério 2,0mm 150mm (cinza)	CC101013
Elétrodo W 2% Cério 2,4mm 150mm (cinza)	CC101090
Elétrodo W 2% Cério 3,2mm 150mm (cinza)	CC103332
Elétrodo W puro 1,6mm 150mm (verde)	CC2000A041161
Elétrodo W puro 2,4mm 150mm (verde)	CC2000A041241
Elétrodo W puro 3,2mm 150mm (verde)	CC2000A041321
Elétrodo W 2% La puro 1,6mm 150mm (azul)	CC101174
Elétrodo W 2% La puro 2,4mm 150mm (azul)	CC101175
Elétrodo W 2% La puro 3,2mm 150mm (azul)	CC103762
Elétrodo W 1% Zircónio 1,6mm 150mm (branco)	CC103333
Elétrodo W 1% Zircónio 2,4mm 150mm (branco)	CC103334
Elétrodo W 1% Zircónio 3,2mm 150mm (branco)	CC103335
Elétrodo 1,5% Lantânio 1,6mm 150mm (gold)	CC107872
Elétrodo 1,5% Lantânio 2,4mm 150mm (gold)	CC107873
Elétrodo 1,5% Lantânio 3,2mm 150mm (gold)	CC111074



Bocais cerâmicos	Ref.	
	Bocal cerâmico 6,4mm 17/18/26 10N50 # 4	CC2G05A0111A0
	Bocal cerâmico 6,4mm 9/20/25 13N08 # 4	CC2G04A0111A0
	Bocal cerâmico 6,4mm 24/24W 53N24 # 4	CC2G03A0111A0
	Bocal cerâmico 8,0mm 17/18/26 10N49 # 5	CC2G05A0111C0
	Bocal cerâmico 8,0mm 9/20/25 13N09 # 5	CC2G04A0111C0
	Bocal cerâmico 8,0mm 24/24W 53N25 # 5	CC2G03A0111C0
	Bocal cerâmico alongado 10N49L # 5	CC110209
	Bocal cerâmico 9,8mm 17/18/26 10N48 # 6	CC2G05A0111E0
	Bocal cerâmico 9,8mm 9/20/25 13N10 # 6	CC2G04A0111E0
	Bocal cerâmico 9,8mm 24/24W 53N27 # 6	CC2G03A0111E0
	Bocal cerâmico 9,8mm 45W	CC113347
	Bocal cerâmico alongado 10N48L # 6	CC110210
	Bocal cerâmico 11,2mm 17/18/26 10N47 # 7	CC2G05A0111F0
	Bocal cerâmico 11,2mm 9/20/25 13N11 # 7	CC2G04A0111F0
	Bocal cerâmico alongado 10N47L # 7	CC110211
	Bocal cerâmico 12,7mm 17/18/26 10N46 # 8	CC2G05A0111G0
	Bocal cerâmico 12,7mm 9/20/25 13N12 # 8	CC2G04A0111G0
	Bocal cerâmico 12,7mm 45W	CC113348
	Bocal cerâmico 15,7mm 17/18/26 10N45 # 10	CC2G05A0111H0
	Bocal cerâmico 15,7mm 9/20/25 13N13 # 10	CC2G04A0111H0
	Bocal cerâmico 15,9mm 45W	CC113349
	Bocal cerâmico 19,0mm 9/20/25 13N09 # 12	CC2G05A0111J0
	Bocal Pyrex 47 mm 17/18/26 28.6mm Jumbo	CC108982
	Bocal Pyrex 32.5 mm 9/20 29mm Jumbo	CC108987
	Bocal cer. prolongador 6,4mm 9/20/24/25 53N58 # 4	CC2G07A0112A0
	Bocal cer. prolongador 6,4mm 17/18/26 54N18 # 4	CC112624
	Bocal cer. prolongador 8,0mm 17/18/26 54N17 # 5	CC2G05A0112C0
	Bocal cer. prolongador 8,0mm 9/20/24/25 53N59 # 5	CC2G07A0112C0
	Bocal cer. prolongador alongado 8,0mm 54N17L # 5	CC110207
	Bocal cer. prolongador 9,8mm 17/18/26 54N16 # 6	CC2G05A0112E0
Bocal cer. prolongador 9,8mm 9/20/24/25 53N60 # 6	CC2G07A0112D0	
Bocal cer. prolongador alongado 9,8mm 54N16L # 6	CC101292	
Bocal cer. prolongador 11,2mm 17/18/26 54N15 # 7	CC2G05A0112F0	
Bocal cer. prolongador 11,2mm 9/20/24/25 53N61 # 7	CC2G07A0112F0	



Bocal cer. prolongador alongado 11,2mm 54N15L # 7	CC110208
Bocal cer. prolongador 12,7mm 17/18/26 54N14 # 8	CC2G05A0112G0
Bocal cer. prolongador 12,7mm 9/20/24/25 53N61S # 8	CC2G07A0112G0
Bocal cer. prolongador Jumbo 12,7mm 57N74 # 8	CC2G05A0114G0
Bocal cer. prolongador 15,7mm 17/18/26 53N88 # 10	CC2G05A0114H0
Bocal cer. prolongador 17,2mm 17/18/26 54N19 # 11	CC2G05A0112I0
Bocal cer. prolongador 19,0mm 17/18/26 53N87 # 12	CC103339

Difusores gás TIG



	Ref.
Difusor gás Pyrex 2.4 mm Jumbo	CC108983
Difusor gás Pyrex 3.2 mm Jumbo	CC108988

Outros acessórios TIG

	Ref.
Afiador eléctrodo W GT-Pulse	CC113117
Afiador eléctrodo W ST-40	CC113116
Suporte magnético tocha TIG	CC102968



ST-40



GT-Pulse

Braços		Ref.
	Braço THi 450mm	PFB340450NS
	Braço THi 450mm tubo	PFB340450TS
	Braço THi 600mm	PFB340600NS
	Braço THi 750mm	PFB340750NS
	Braço THi 900mm	PFB340900NS

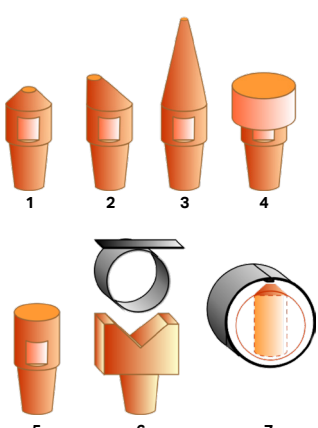
Pontos		Ref.
	Ponto 20X47 standard CuCrZr (1)	PFH7L12010C04700
	Ponto 20X47 standard CuCo2Be (1)	PFH7J12010C04700
	Ponto 20X50 excêntrico (2)	PFH7L22010C05007
	Ponto 20X90 alongado (3)	PFH7L12010C09000
	Ponto 20X90 alongado CuCo2Be (3)	PF104172
	Ponto 20X110 alongado (3)	PF102318
	Ponto 13/27 rótula (4)	CC107393
	Ponto 20X50 rótula (4)	CC4000A19R205030
	Ponto 20X50 plano (5)	PF102836
	Ponto 20X50 diam. 6-11mm (5)	PF104086
	Ponto 30X50X74,5 tubos ext. Refrigerado (6)	PFH7L60010C07400
	Ponto 25X50 tubos int. diam. min. 60mm (7)	PFH7L32510C05000
	Ponto 25X50 tubos int. CuCo2Be (7)	PF105071
	Ponto inferior porca M3	PF131321
	Ponto superior porca M3	PF131322
	Ponto inferior porca M4	PF131269
	Ponto superior porca M4	PF131270
	Ponto inferior porca M5	PF131271
	Ponto superior porca M5	PF131272
	Ponto inferior porca M6	PF131273
	Ponto superior porca M6	PF131274
	Ponto inferior porca M8	PF131275
	Ponto superior porca M8	PF131276
	Ponto inferior porca M10	PF131277
	Ponto superior porca M10	PF131278
	Ponto inferior porca M12	PF131279
	Ponto superior porca M12	PF131280



Pontos cápsula

Ref.

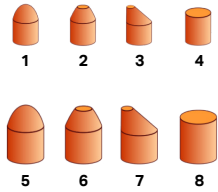

Ponto cápsula forma D-13 (1)	CO100436
Ponto cápsula forma L-13 (2)	CC100891
Ponto cápsula forma K-13 (3)	CC100892
Ponto cápsula forma M-13 (4)	CC100893
Ponto cápsula forma A-16 (5)	CO9SE11610C105
Ponto cápsula forma B-16 (6)	CO9SG11610C105
Ponto cápsula forma E-16 (7)	CO9SD11610C105
Ponto cápsula forma N-16 (8)	CO9SN11610C105

Suportes ponto

Ref.



Suporte ponto 25X60 1/8 cpl	PFJ2Q0600250255C
Suporte ponto 25X190 1/8 cpl	PFJ2Q1900250255C
Suporte ponto 25X320 1/8 cpl	PFJ2Q3200250255C
Suporte ponto 25X380 1/8 cpl	PFJ2Q3800250255C
Suporte ponto cápsula 20X50X13	PF102943
Suporte ponto cápsula 20X50X16	PFJ2X0500200200S

Tubos

Ref.



Tubo gás 8,00X5,00mm vermelho	MP041208000150C1
Tubo gás 8,00X5,00mm azul	MP041208000150C2
Tubo ELECTREX 6mm vermelho	MP101607
Tubo ELECTREX 6mm azul	MP104543

Outros acessórios pontos

Ref.

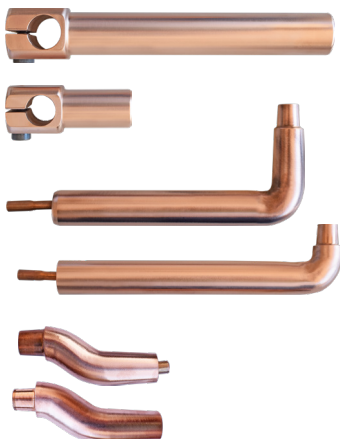

Suporte porta-elérodos d25X80mm	CC100084
Suporte porta-elérodos d25X190mm	CC100085
Porta-elérodos d19X125X55mm	CC100087
Porta-elérodos d19X150X29,5mm	CC101305
Porta-elérodos d19X200X29,5mm	CC104075
Cabeça de refrigeração 35-1/4G-1/8" cpl	PF103319



ACESSÓRIOS GÁS

Reguladores	Ref.	
	Maçarico de aquecimento e soldadura propano	CC114633
	Manorredutor Oxigénio 230/20bar	CC114641
	Manorredutor Oxigénio 230/50bar	CC114642
	Manorredutor Acetileno 25/1,5bar	CC114634
	Manorredutor Acetileno 25/1,5bar Estribo	CC114635
	Manorredutor Propano 4bar	CC114636
	Manorredutor Hélio 230/10bar	CC114637
	Manorredutor Hélio Balões	CC114645
	Manorredutor Hidrogénio 230/10bar	CC114638
	Manorredutor Azoto 230/4bar	CC114639
	Manorredutor Azoto 230/10bar	CC114640
	Manorredutor Azoto 230/20bar	CC114643
	Manorredutor Azoto 230/50bar	CC114644
	Debitómetro Árgon/Co2 230/21l-min	CC114646
	Debitómetro Árgon/Co2 230/30l-min Coluna	CC114647
	Debitómetro Árgon/Co2 230/30l-min Dupla Coluna	CC114648
	Regulador Linha Oxigénio 10bar	CC114649
	Regulador Linha Acetileno 1,5bar	CC114650
	Regulador Linha Propano 4bar	CC114651
	Regulador Linha Árgon/Co2 21l-min	CC114652
	Regulador Linha Árgon/Co2 30l-min Dupla Coluna	CC114653
	Regulador Linha Árgon/Co2 30l-min Coluna	CC114654



Acessórios diversos reguladores

Ref.



Economizador de gás Árgon/Co2 Fixo	CC114655
Economizador de gás Árgon/Co2 Regulável	CC114656
Pré Aquecedor Co2 230V/75W	CC114657
Pré Aquecedor Co2 230V/150W	CC114658
Manómetro 0- 40/25 bar (Ø 63 mm) Acetileno	CC114659
Manómetro 0- 2,5/1,5 bar (Ø 63 mm) Acetileno	CC114660
Manómetro 0- 315/230 bar (Ø 63 mm) Oxigénio	CC114661
Manómetro 0-16/10 bar (Ø 63 mm) Oxigénio	CC114662
Manómetro 0- 315/230 bar (Ø 63 mm) Árgon/Co2	CC114663
Manómetro 0- 32/21 l-min (Ø 63 mm) Árgon/Co2	CC114664
Proteção borracha simples laranja Ø 63 mm	CC114665
Proteção borracha dupla azul Ø 63 mm	CC114666
Proteção borracha dupla vermelha Ø 63 mm	CC114667
Proteção borracha dupla cizenta Ø 63 mm	CC114668
Porca G1/4	CC114669
Porca G1/4L	CC114670
Porca G3/8	CC114671
Porca G3/8L	CC114672
Porca G9/16	CC114673
Porca G9/16L	CC114674
Porca M16x1,5	CC114675
Porca M16x1,5L	CC114676
Racord mangueira G1/4 - Ø6-8mm	CC114677
Racord mangueira G1/4L - Ø6-8mm	CC114678
Racord mangueira G3/8 - Ø6-8mm	CC114679
Racord mangueira G3/8L - Ø6-8mm	CC114680
Racord mangueira G9/16 - Ø6-8mm	CC114681
Racord mangueira G9/16L - Ø6-8mm	CC114682
Racord mangueira M16x1,5 - Ø6-8mm	CC114683
Racord mangueira M16x1,5L - Ø6-8mm	CC114684



ACESSÓRIOS GÁS

Válvulas de segurança e mangueiras de gás

Ref.



Kit Válvula de segurança regulador Oxigénio ligação rápida - G3/8

CC114685

Kit Válvula de segurança regulador Gas ligação rápida - G3/8L

CC114686

Kit Válvula de segurança maçarico Oxigénio ligação rápida - G1/4

CC114687

Macho Oxigénio Ligação rápida - G1/4

CC114688

Fêmea Válvula de segurança Oxigénio Ligação rápida - Ø6-8mm

CC114689

Kit Válvula de segurança maçarico Gas ligação rápida - G3/8L

CC114690

Macho Gas Ligação rápida - G3/8L

CC114691

Fêmea Válvula de segurança Gas Ligação rápida - Ø6-8mm

CC114692

Kit Válvula de segurança maçarico Oxigénio ligação rápida - G9/16x18

CC114693

Macho Oxigénio Ligação rápida - G9/16x18

CC114694

Fêmea válvula de segurança Oxigénio Ligação rápida - Ø6-8mm (G9/16x18)

CC114695

Kit Válvula de segurança maçarico Gas ligação rápida - G9/16x18L

CC114696

Macho Gas Ligação rápida - G9/16x18L

CC114697

Fêmea válvula de segurança Gas Ligação rápida - Ø6-8mm (G9/16x18L)

CC114698

Macho Oxigénio Ligação rápida - Ø6-8mm

CC114699

Macho Gas Ligação rápida - Ø6-8mm

CC114700

Fêmea válvula de segurança Oxigénio Maçarico G1/4 - Ø6-8mm

CC114701

Fêmea válvula de segurança Gas Maçarico G3/8L - Ø6-8mm

CC114702

Fêmea válvula de segurança Oxigénio Maçarico G9/16 - Ø6-8mm

CC114703

Fêmea válvula de segurança Gas Maçarico G9/16L - Ø6-8mm

CC114704

Válvula de segurança Oxigénio - Ø6-8mm

CC114705

Válvula de segurança Gas - Ø6-8mm

CC114706

Macho Árgon/Co2 Ligação rápida - Ø6-8mm

CC114707

Fêmea Árgon/Co2 Ligação rápida - Ø6-8mm

CC114708

Fêmea Oxigénio Ligação rápida - Ø6-8mm

CC114709

Fêmea Gas Ligação rápida - Ø6-8mm

CC114710

Mangueira Oxigénio 6,3 x 12,3mm (rolos com 20mts)

CC114904

Mangueira Oxigénio 8,0 x 15,0mm (rolos com 50mts)

CC114895

Mangueira Oxigénio 10,0 x 17,0mm (rolos com 20mts)

CC114896

Mangueira Acetileno 6,3 x 12,3mm (rolos com 20mts)

CC114897

Mangueira Acetileno 8,0 x 15,0mm (rolos com 50mts)

CC114898

Mangueira Acetileno 10,0 x 17,0mm (rolos com 20mts)

CC114899

Mangueira Propano 8,0 x 15,0mm (rolos com 20mts)

CC114900

Mangueira Oxigénio / Acetileno 6,3mm (rolos com 25mts)

CC114901

Mangueira Oxigénio / Acetileno 8,0mm (rolos com 25mts)

CC114902

Mangueira Oxigénio / Acetileno 10,0mm (rolos com 25mts)

CC114903





Maçarico corte CI

Ref.



Maçarico corte CI Multigas 450mm - 90°	CC114711
Maçarico corte CI Multigas 750mm - 90°	CC114712
Maçarico corte CI Multigas 1000mm - 75°	CC114713
Maçarico corte CI Multigas 1500mm - 75°	CC114714
Compasso maçarico corte CI 80-800mm	CC114715
Bico corte CI Acetileno 3-6mm	CC114716
Bico corte CI Acetileno 5-12mm	CC114717
Bico corte CI Acetileno 10-75mm	CC114718
Bico corte CI Acetileno 70-100mm	CC114719
Bico corte CI Acetileno 90-150mm	CC114720
Bico corte CI Acetileno 140-200mm	CC114721
Bico corte CI Acetileno 190-300mm	CC114722
Bico corte CI Acetileno 300-500mm	CC114723
Bico corte CI Propano 3-6mm	CC114724
Bico corte CI Propano 5-12mm	CC114725
Bico corte CI Propano 10-75mm	CC114726
Bico corte CI Propano 70-100mm	CC114727
Bico corte CI Propano 90-150mm	CC114728
Bico corte CI Propano 140-200mm	CC114729
Bico corte CI Propano 190-300mm	CC114730
Bico corte CI Propano 300-500mm	CC114731



MAÇARICOS DE CORTE

Maçarico corte G1

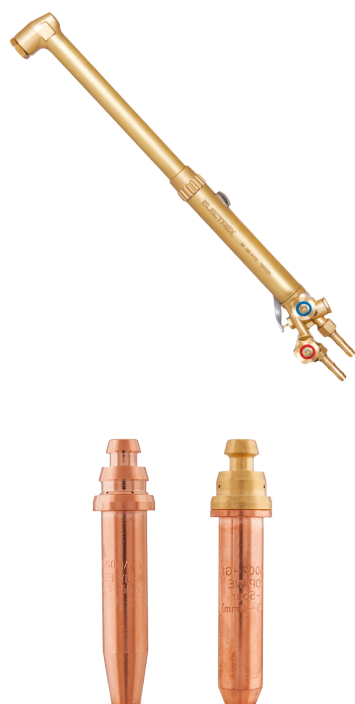

	Ref.
Maçarico corte G1 Multigas 500mm - 90°	CC114732
Bico corte G1 Acetileno 3-10mm 7/10	CC114733
Bico corte G1 Acetileno 10-25mm 10/10	CC114734
Bico corte G1 Acetileno 25-50mm 12/10	CC114735
Bico corte G1 Acetileno 50-80mm 16/10	CC114736
Bico corte G1 Acetileno 80-120mm 20/10	CC114737
Bico corte G1 Acetileno 120-200mm 25/10	CC114738
Bico corte G1 Acetileno 200-300mm 30/10	CC114739
Bico corte G1 Propano 3-10mm 7/10	CC114740
Bico corte G1 Propano 10-25mm 10/10	CC114741
Bico corte G1 Propano 25-50mm 12/10	CC114742
Bico corte G1 Propano 50-80mm 16/10	CC114743
Bico corte G1 Propano 80-120mm 20/10	CC114744
Bico corte G1 Propano 120-200mm 25/10	CC114745
Bico corte G1 Propano 200-300mm 30/10	CC114746

Maçarico corte H



	Ref.
Maçarico corte H Acetileno 450mm - 90°	CC114747
Maçarico corte H Propano 450mm - 90°	CC114748
Compasso maçarico corte H 80-800mm	CC114749
Bico corte H 000 A 0-5mm	CC114750
Bico corte H 00 A 5-10mm	CC114751
Bico corte H 0 A 10-15mm	CC114752
Bico corte H 1 A 15-25mm	CC114753
Bico corte H 2 A 25-50mm	CC114754
Bico corte H 3 A 50-100mm	CC114755
Bico corte H 4 A 100-175mm	CC114756
Bico corte H 5 A 175-250mm	CC114757
Bico corte H 6 A 250-300mm	CC114758
Bico corte H 000 AC 1-5mm	CC114759
Bico corte H 00 AC 5-10mm	CC114760
Bico corte H 0 AC 10-15mm	CC114761



Bico corte H 1 AC 15-25mm	CC114762
Bico corte H 2 AC 25-50mm	CC114763
Bico corte H 3 AC 50-75mm	CC114764
Bico corte H 4 AC 75-150mm	CC114765
Bico corte H 5 AC 150-200mm	CC114766
Bico corte H 6 AC 200-300mm	CC114767
Bico corte H 000 P 1-5mm	CC114768
Bico corte H 00 P 5-10mm	CC114769
Bico corte H 0 P 10-15mm	CC114770
Bico corte H 1 P 15-25mm	CC114771
Bico corte H 2 P 25-50mm	CC114772
Bico corte H 3 P 50-75mm	CC114773
Bico corte H 4 P 75-150mm	CC114774
Bico corte H 5 P 150-200mm	CC114775
Bico corte H 6 P 200-300mm	CC114776

Conjunto de corte / soldadura / aquecimento

Ref.

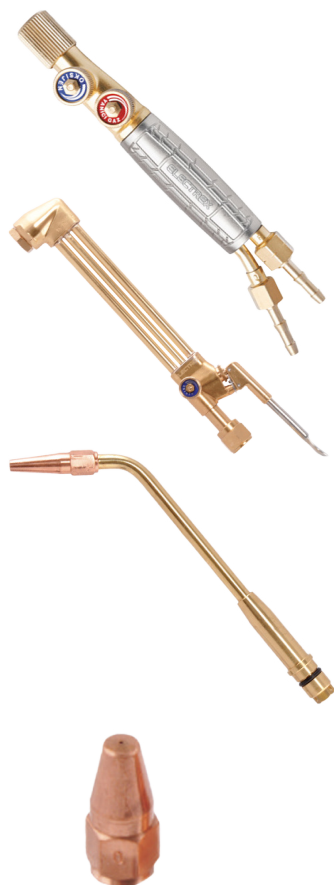

Punho geral 16mm - G1/4 - G3/8L	CC114777
Maçarico corte CI - Punho (0-300mm)	CC114778
Lança soldadura + Bico soldadura 0,2-0,5mm	CC114779
Lança soldadura + Bico soldadura 0,5-1mm	CC114780
Lança soldadura + Bico soldadura 1-2mm	CC114781
Lança soldadura + Bico soldadura 2-4mm	CC114782
Lança soldadura + Bico soldadura 4-6mm	CC114783
Lança soldadura + Bico soldadura 6-9mm	CC114784
Lança soldadura + Bico soldadura 9-14mm	CC114785
Lança soldadura + Bico soldadura 14-20mm	CC114786
Lança soldadura + Bico soldadura 20-30mm	CC114787
Bico soldadura 0,2-0,5mm	CC114788
Bico soldadura 0,5-1mm	CC114789
Bico soldadura 1-2mm	CC114790
Bico soldadura 2-4mm	CC114791
Bico soldadura 4-6mm	CC114792
Bico soldadura 6-9mm	CC114793



MAÇARICOS DE CORTE

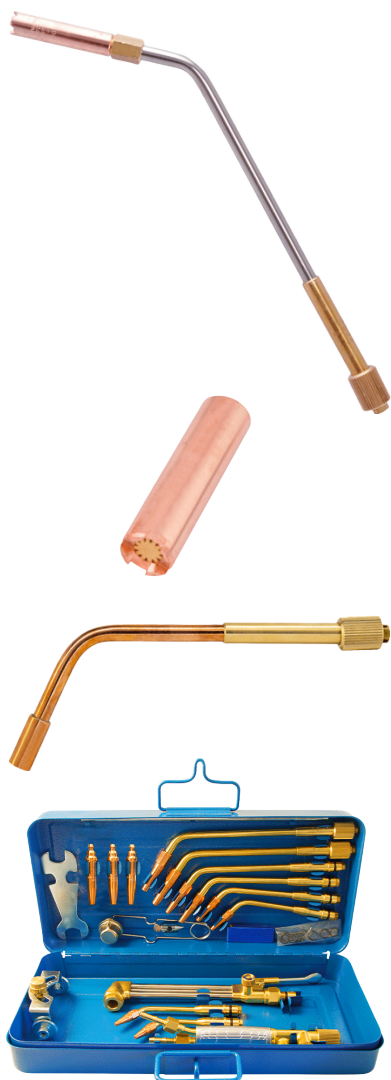

Bico soldadura 9-14mm	CC114794
Bico soldadura 14-20mm	CC114795
Bico soldadura 20-30mm	CC114796
Lança aquecimento 420mm + Bico aquecimento propano 1	CC114797
Lança aquecimento 420mm + Bico aquecimento propano 2	CC114798
Lança aquecimento 490mm + Bico aquecimento propano 3	CC114799
Lança aquecimento 600mm + Bico aquecimento propano 4	CC114800
Lança aquecimento 670mm + Bico aquecimento propano 5	CC114801
Bico aquecimento propano 1	CC114802
Bico aquecimento propano 2	CC114803
Bico aquecimento propano 3	CC114804
Bico aquecimento propano 4	CC114805
Bico aquecimento propano 5	CC114806
Lança aquecimento 366mm + Bico aquecimento acetileno 4	CC114807
Lança aquecimento 366mm + Bico aquecimento acetileno 6	CC114808
Lança aquecimento 366mm + Bico aquecimento acetileno 8	CC114809
Lança aquecimento 436mm + Bico aquecimento acetileno 10	CC114810
Mala com conjunto soldadura (0,5-30mm) e corte CI (0-300mm)	CC114811
Conjunto Punho Light + Lança de corte acetileno (0-100mm)	CC114812
Conjunto Punho Light + Lança de corte propano (0-100mm)	CC114813
Lança de corte acetileno (0-100mm)	CC114814
Lança de corte propano (0-100mm)	CC114815
Punho Light	CC114816

Maçarico soldadura

Ref.



Maçarico soldadura + Estrela 7 bicos acetileno	CC114817
Estrela 7 bicos acetileno	CC114818
Estrela 7 bicos propano	CC114819

Maçarico de aquecimento e soldadura propano

Ref.



Punho propano com gatilho G3/8L - Ø6-8mm	CC114821
Lança com bocal de aquecimento tubos Ø22mm	CC114822
Bocal de aquecimento tubos Ø22mm	CC114823
Lança de ligação 60mm	CC114824

MAÇARICOS DE CORTE

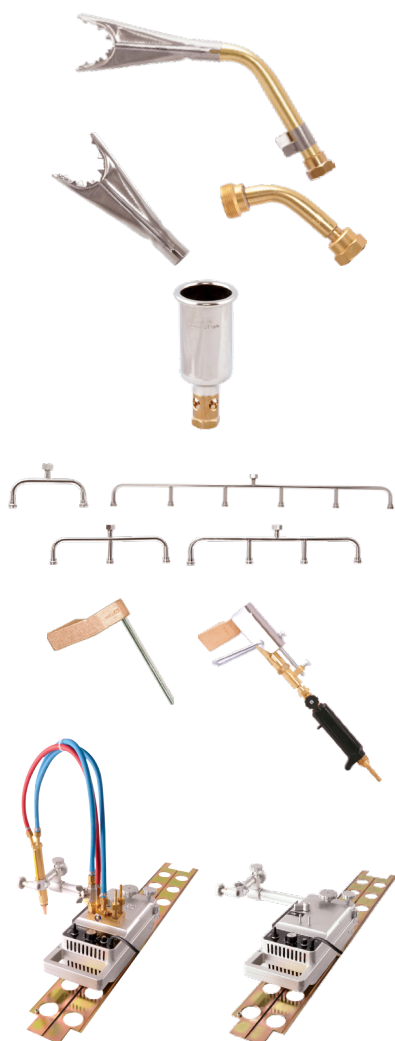

Lança de ligação 100mm	CC114825
Lança de ligação 200mm	CC114826
Lança de ligação 400mm	CC114827
Lança de ligação 600mm	CC114828
Lança de ligação 750mm	CC114829
Lança de ligação 1000mm	CC114830
Bocal de aquecimento propano Ø45mm	CC114831
Bocal de aquecimento propano Ø51mm	CC114832
Bocal de aquecimento propano Ø57mm	CC114833
Bocal de aquecimento propano Ø63mm	CC114834
Lança de conexão 2 saídas	CC114835
Lança de conexão 3 saídas	CC114836
Lança de conexão 4 saídas	CC114837
Lança de conexão 6 saídas	CC114838
Conjunto de ferro de soldar (tipo martelo) 500gr G3/8L - Ø6-8mm	CC114839
Ponteira de cobre 350gr	CC114840
Ponteira de cobre 500gr	CC114841
Ponteira de cobre pontiaguda 250gr	CC114842
Ponteira de cobre pontiaguda 350gr	CC114843
Carro de corte automático oxi-gas (um maçarico) + Rail 2mts	CC114844
Carro de corte automático plasma (uma tocha) + Rail 2mts	CC114845

Outros acessórios



	Ref.
Carro transporte garrafa propano standard	CC114894
Carro transporte garrafas oxigénio-acetileno standard	CC114890
Carro transporte garrafas oxigénio-propano standard	CC114891
Carro transporte garrafa oxigénio reforçado	CC114892
Carro transporte garrafa oxigénio standard	CC114893
Isqueiro tipo copo c/kit pedras	CC114289
Pedras Isqueiro (5 unidades)	CC114859
Kit limpeza bicos	CC114290
Óculos corte ø50mm	CC114291



ACESSÓRIOS PLASMA

Tochas Plasma Tecmo

Tocha plasma PT60



CC105807

Tocha plasma PT100



CC105773

Tocha plasma PTM100



CC111993

Tochas TECMO

Ref.

Preço

PT 60

Bico corte 0,65mm PT60 (1)	CC105816
Bico corte 0,80mm PT60 (1)	CC105815
Bico corte 0,90mm PT60 (1)	CC105103
Bico corte 1.10 mm 50-60A PT60 (1)	CC111728
Bico corte arrasto 1,00mm PT60 (1)	CC106882
Bico corte arrasto 1,10mm PT60 (1)	CC111548
Difusor ar PT60 (2)	CC105104
Eléctrodo plasma PT60 (3)	CC105105
Bocal termoplástico PT60 (4)	CC105101
Bocal termoplástico roscado PT60 (14)	CC111559
Bocal corte arrasto roscado PT60 (13)	CC111560
Distanciador 2 pinos PT60 (5)	CC105102
Compasso corte circular PT60 (6)	CC112207
Cabeça tocha PT60 (7)	CC105808
Punho tocha PT60 (8)	CC105811

PT 100

Bico corte 1,40mm PT100 (1)	CC105108
Bico corte 1,50mm PT100 (1)	CC105109
Bico corte arrasto 1,50mm PT100 (1)	CC112177
Bico chanfro PT100 (1)	CC111309



Difusor ar PT100 (2)	CC105110
Regulador ar PT100 (9)	CC105112
Eléctrodo plasma PT100 (3)	CC105111
Bocal termoplástico PT100 (4)	CC105106
Bocal termoplástico roscado PT100	CC111310
Bocal corte arrasto PT100	CC112178
Bocal chanfro PT100	CC111311
Distanciador 2 pinos PT100	CC105107
Compasso corte circular PT100	CC112208
Cabeça tocha PT100	CC105810
Cabeça tocha PTM100	CC111994
Punho tocha PT100 cpl	CC105813
O'ring PTM100	CC111995
Tubo posicionamento tocha PTM100	CC111996
Interruptor tocha PT60/100	CC105814

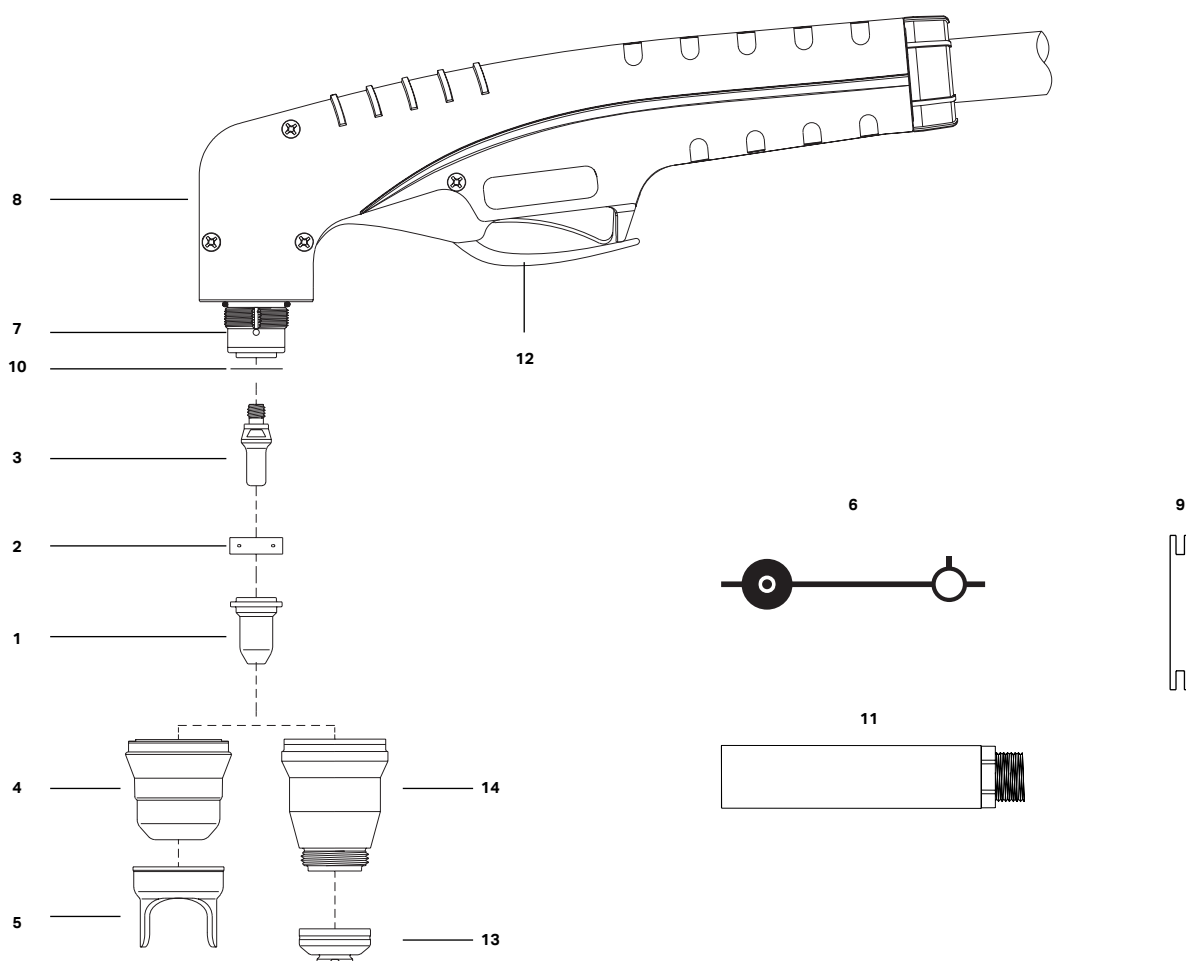



ACESSÓRIOS PLASMA

Tochas Plasma Trafimet

Tocha plasma A101



Sem pantógrafo	CC3101C131061
Com pantógrafo	CC107916

Tocha plasma A151



Sem pantógrafo	CC3151C131061
Com pantógrafo	CC3150C132062

Tochas Trafimet

Ref.



Regulador ar FH562 A101 (1)

CC3100C120000



Regulador ar FH563 A151 (1)

CC3150C120000

Difusor ar PE101 A101 (2)

CC3000C040003

Difusor ar PE103 A151 (2)

CC3000C040004



Eléctrodo standard PR101 A101 (3)

CC3000C060000

Eléctrodo standard PR111 A151 (3)

CC3145C060000



Eléctrodo longo PR116 A101/151 (4)

CC3000C060001

Bico corte PD101 1,10mm A101 (4)

CC3000C010111

Bico corte PD101 1,40mm A101 (4)

CC3000C010141

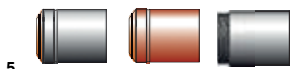

Bico corte PD109 1,40mm A151 (4)

CC3145C010141

Bico corte PD109 1,60mm A151 (4)

CC3145C010161

Bico corte PD101 1,70mm A101 (4)

CC3000C010171

Bico corte PD109 1,80mm A151 (4)

CC3145C010181

Bico corte PD101 1,90mm A101 (4)

CC3000C010191

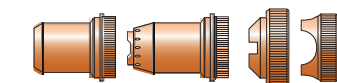

Bico corte longo PD117 1,40mm A101/151 (4)

CC3000C010143

Bico corte longo PD117 1,70mm A101/151 (4)

CC3000C010173

Bico corte longo PD117 1,90mm A101/151 (4)

CC3000C010193



Bocal standard PC109 A101 (5)

CC3090C020003

Bocal standard PC120 A151 (5)

CC104561





Bocal standard PC101 A151(5)

CC3140C020003

Bocal roscado PC130 A101(5)

CC3100C020004



Tochas Trafimet		Ref.
7 	Bocal roscado PC103 A151 (5)	CC3140C020004
	8 	Mola guia CV11 A101/151
9 	Distanciador longo CV09 A101/151 (6)	CC3000C050005
	Distanciador longo CV1105 A101/151 (6)	CC104560
10 	Distanciador CV0014 A101/151(6)	CC102556
	Distanciador CV0039 A101/151(6)	CC102555
	Distanciador rotativo CV21 A101/151(6)	CC3000C050004
	Barra radial 500mm para compasso	PF100793
	Pino para barra radial com compasso	PF100794
	Cabeça tocha A101 (7)	CC3100C030001
	Cabeça tocha A151 (7)	CC3150C030001
	Cabeça tocha A151 pantógrafo (7)	CC100483
	Cabeça tocha A101 pantógrafo (7)	CC3100H030002
	O'ring cabeça tocha A101/151 (8)	CC104559
	Punho tocha A101/151 (9)	CC100437
	Interruptor tocha A101/151 (10)	CC1000C120002

SERVIÇO ELECTREX

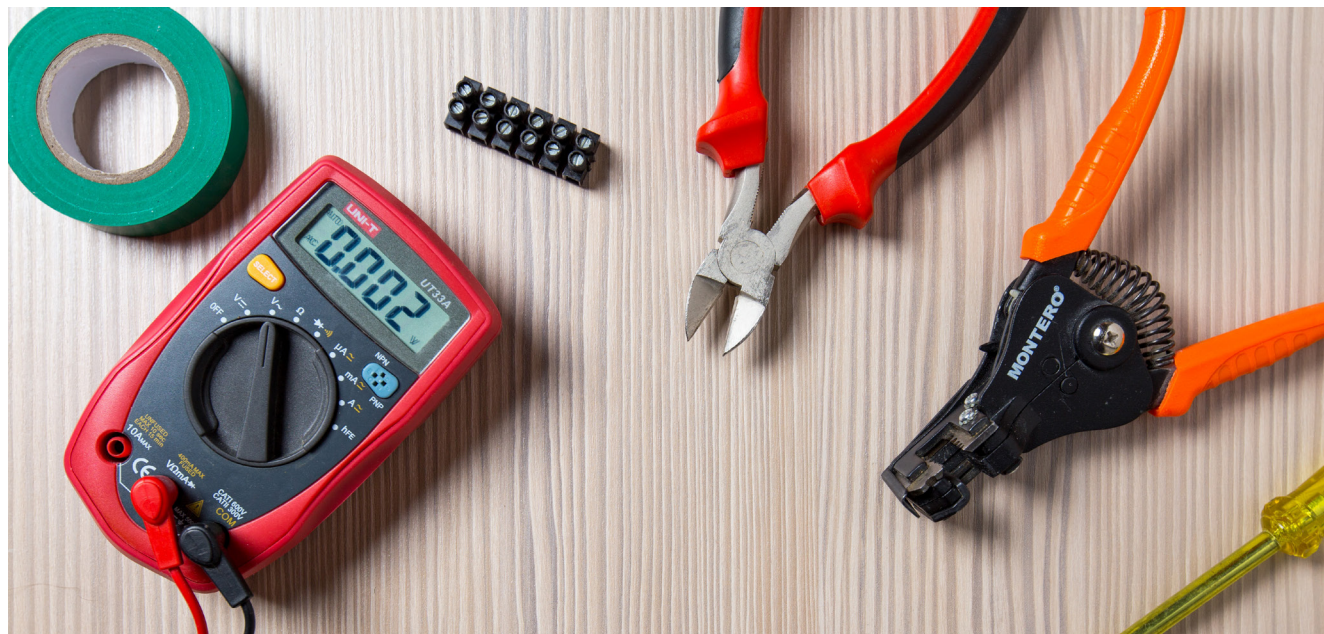

ASSISTÊNCIA TÉCNICA

Temos uma equipa técnica especializada à sua disposição, com procedimentos de reparação homologados e com peças de substituição originais Electrex.



GARANTIA

Os nossos equipamentos são fabricados com rigorosos processos de produção e testados para funcionarem nas condições mais exigentes, garantindo a sua fiabilidade e durabilidade.



TEM DÚVIDAS TÉCNICAS

Na Electrex estamos sempre disponíveis para ouvir e a responder às necessidades dos nossos clientes com o máxima brevidade possível. Use os nossos canais de comunicação rápidos Skype e WhatsApp para esclarecer as suas dúvidas ou dificuldades técnicas.

Luciano Santos:

 (+351) 961 939 968



● Pontos de distribuição

📍 Electrex Portugal

ELECTREX - João R. Matos S.A.
Rua do Viso - Santa Joana
3810-375 Aveiro | PORTUGAL

Telf: (+351) 234 313 433
Fax: (+351) 234 313 024

info@electrexwelding.com
www.electrexwelding.com



WELDING SINCE 1946

ELECTREX - João R. Matos S.A.
Rua do Viso - Santa Joana
3810-375 Aveiro | PORTUGAL

Telf: (+351) 234 313 433
Fax: (+351) 234 313 024



info@electrexwelding.com
www.electrexwelding.com

